



Shenzhen Century sunshine Lighting Limited



BSS series specifications

www.centurysunshine.com

Product Details

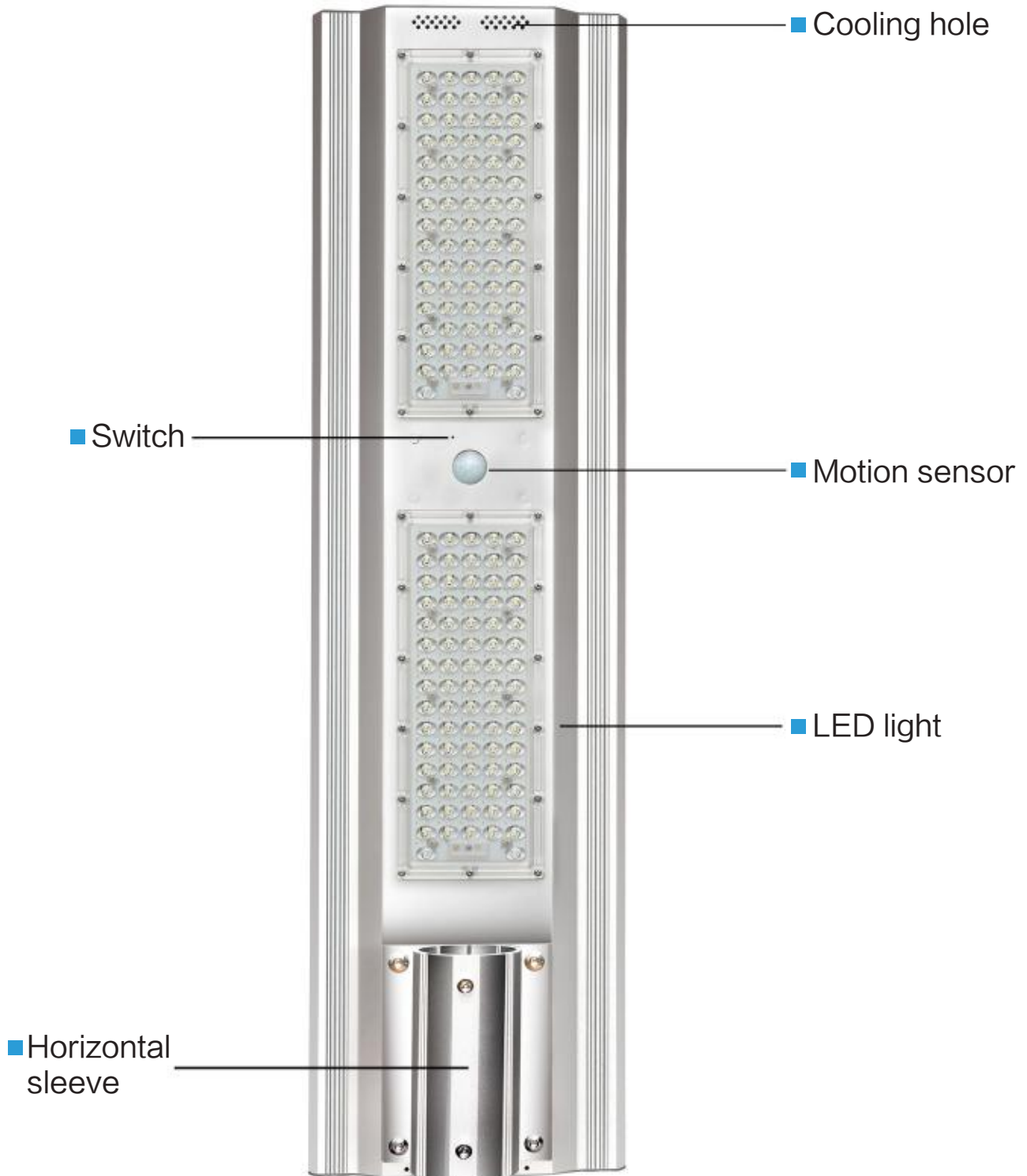

Product Feature



Horizontal sleeve



Intelligent sensor



There are multi-working modes in one lamp, you can change its working mode as you need.



One-time molded aluminum has better heat dissipation performance and better endurance effect



The surface is treated with special paint



Modular 3030 light source, super high brightness

PRODUCT ADVANTAGES



Sensing distance
10 meters

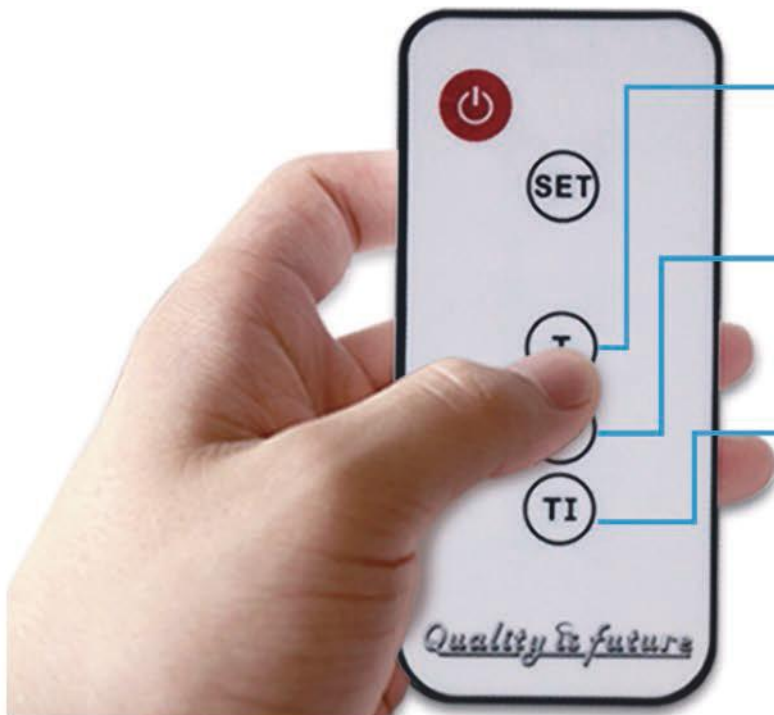

- **TIME CONTROL MODE:**
press SET button + T button, wait 3 seconds, then it enter time control mode
- **SENSOR CONTROL MODE:**
press SET button + I button, wait 3 seconds, then it enter sensor control mode
- **MIXED CONTROL MODE:**
press SET button + TI button, wait 3 seconds, then it enter mixed control mode

PRODUCT ADVANTAGES

- Easily set the working mode of solar street light;
- 10 meters infrared sensing range of remote control, suitable for most installation height
- Multiple working modes to deal with various complex environments
- According to the demand, the running time can be reasonably controlled, and it can last for a long time in the rainy days.

T—— (Time control mode) ; I——(Sensor control mode) ;
TI: (Mixed control mode, time control in the first 6 hours; sensor control in the last 6 years)

Sensing range

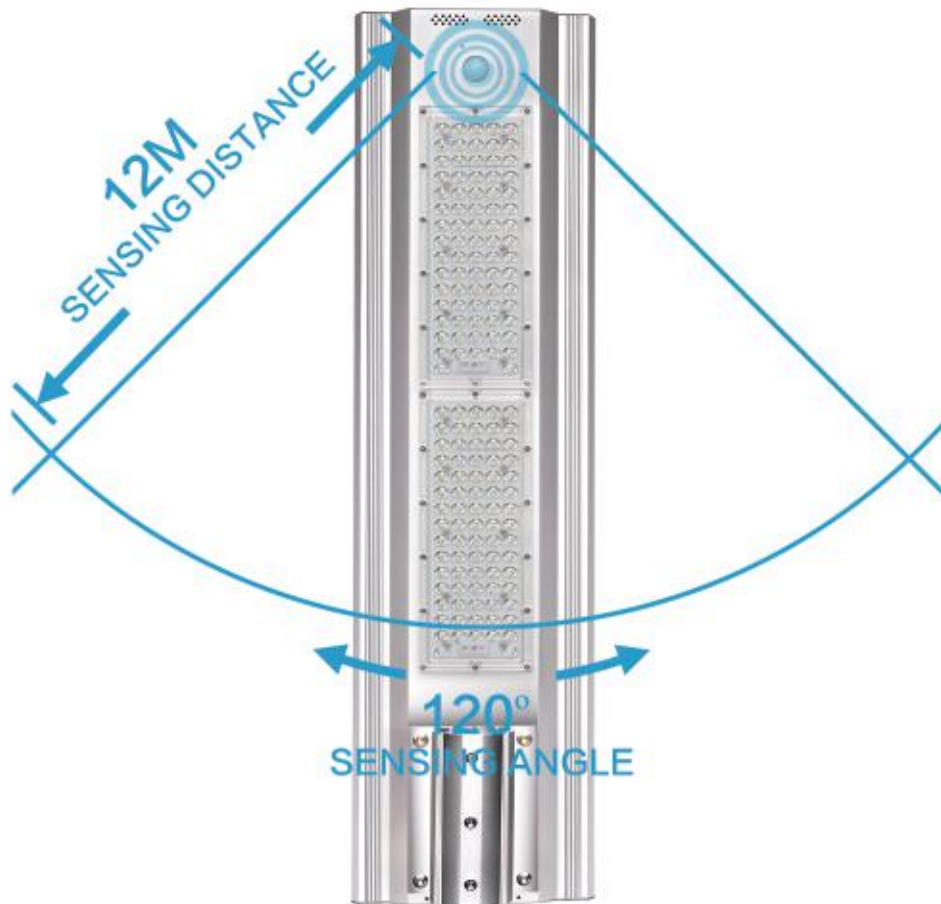

Sensing effect

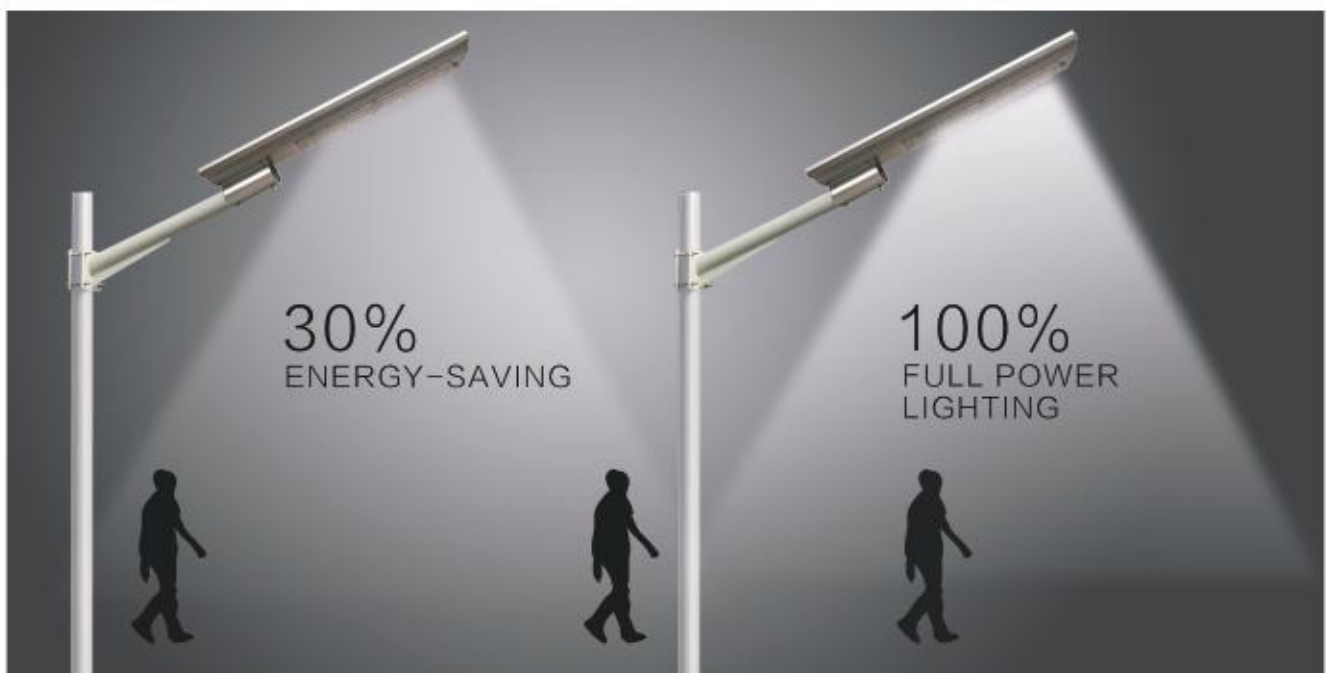

Materials Introduction:

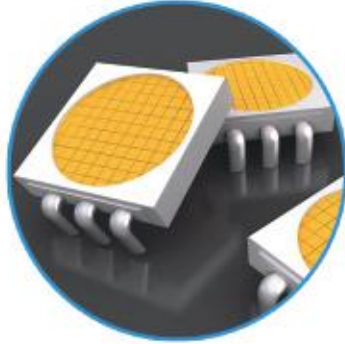

LED energy-saving light source:

imported USA Bridgelux LED, super high light efficiency, long-lasting lighting

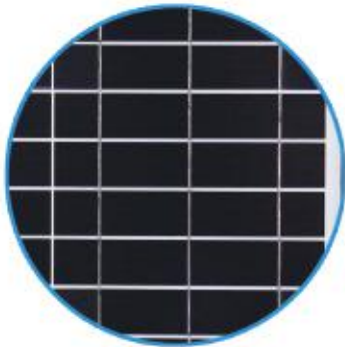

Solar panel:

high-efficiency solar panel, high conversion rate, special surface treatment



Aluminium alloy material:

One-time molded aluminum has better heat dissipation performance and better endurance effect

Product Advantages



Easy to install and maintain



Multiple control modes for easy operation



Long life span of LED chip



Customized battery box, waterproof and high temperature resistant;



Solar panel, high conversion rate



Intelligent turn-on lighting mode

Product Size:

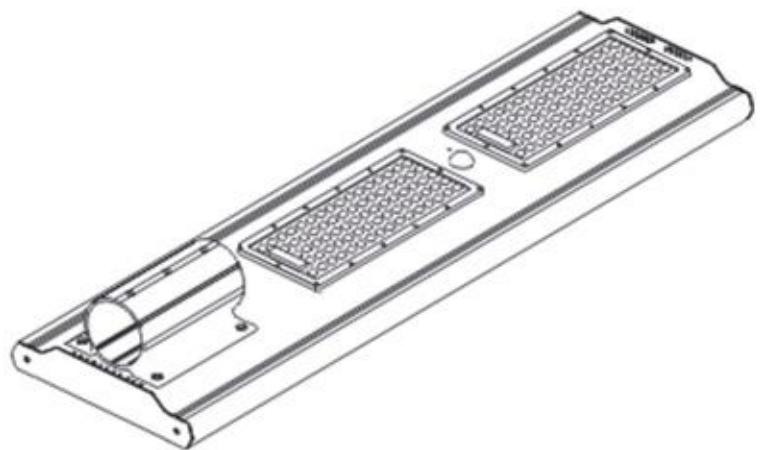
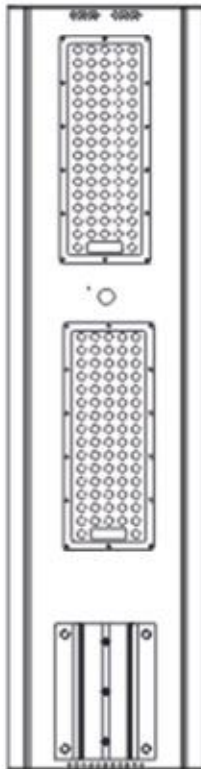

Installation Procedure:

1. Choose the best position for lighting.
2. Open the package and check if the accessories are complete.
3. Use the ejector pin to open the switch before installation

■ Matters needing attention:

When the LED light source is working, the red indicator light is fully illuminated.
When the LED light source is not working, the red indicator light is off.

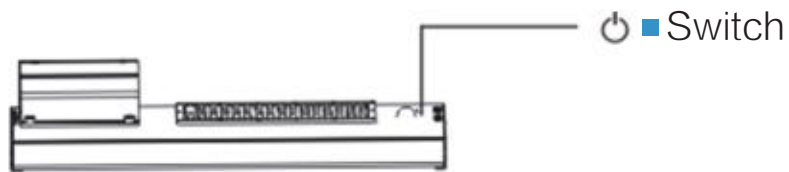

4. Firstly, fix the base to the lifting device with screws, then put the solar panel of the lamp body up, insert the lamp into the pole with the base facing down, and tighten the screws. (As figure 1)

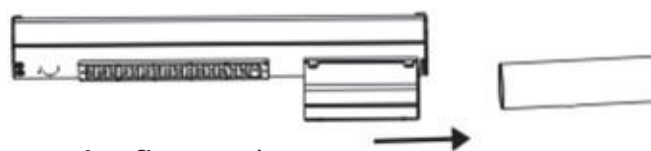

As figure 1

Warm prompt:

- During installation, one or two people shall hold the lamp body, and another person shall tighten the nut, so as to avoid misplacement of the nut due to force during the tightening process, or would result in nut sticking and subsequent undisassembly;
- It is recommended to install on a sunny day, because it can't be charged quickly after installation in rainy days, and it will be discharged at night, which will affect the using effect.
- If the lamp does not work after the package is opened, it is usually because the battery power is insufficient. Charge it for 2 days before installation.



Spectra:

See our luminaire catalog for an image of the luminaire.

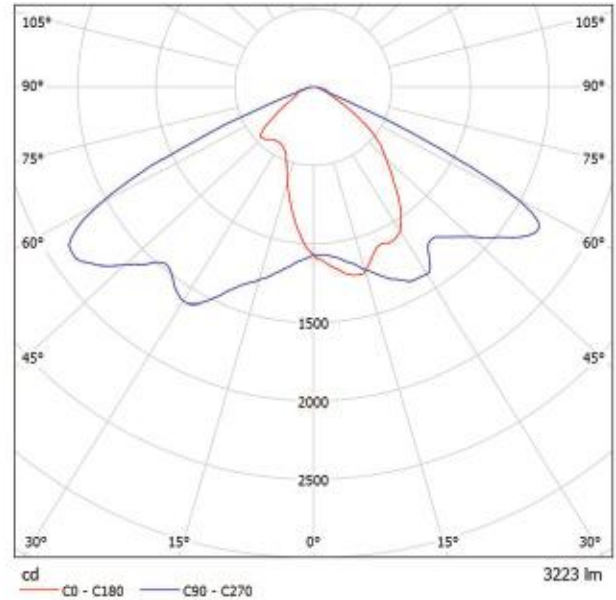

Luminaire classification according to CIE: 100
CIE flux code: 56 88 98 100 100

Due to missing symmetry properties, no UGR table can be displayed for this luminaire.

Road lighting simulation

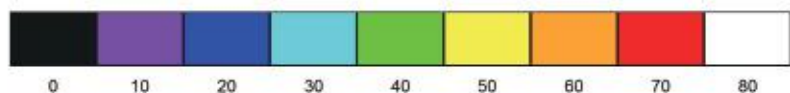
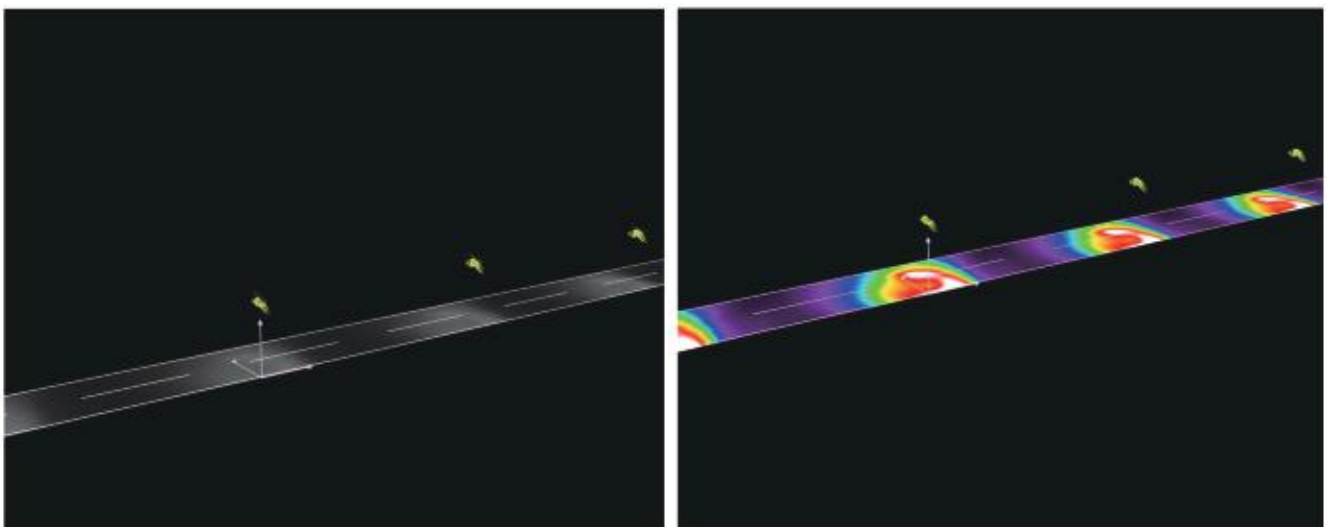

Note 1

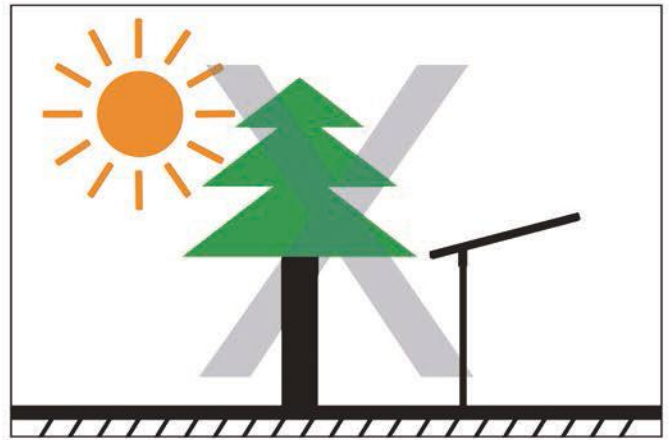
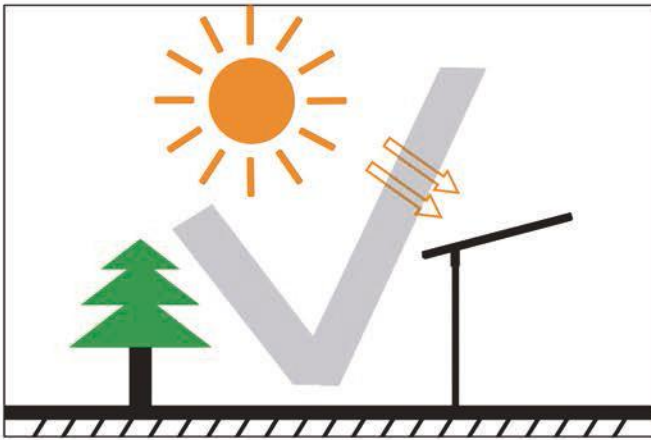

Note 2

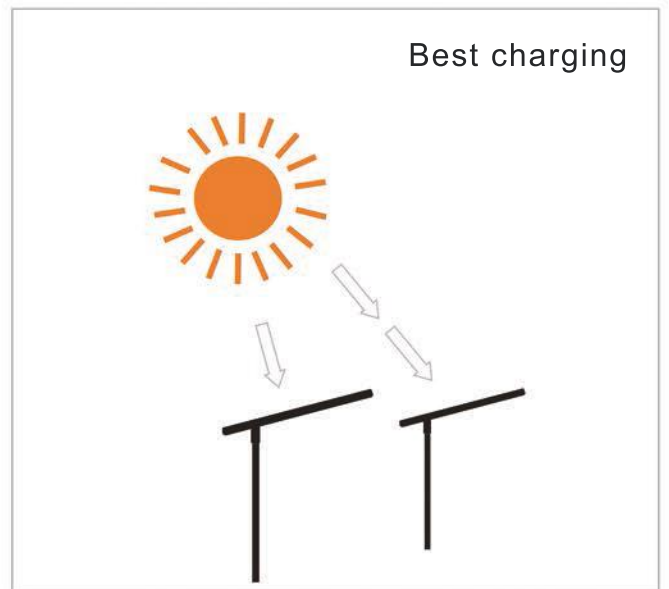
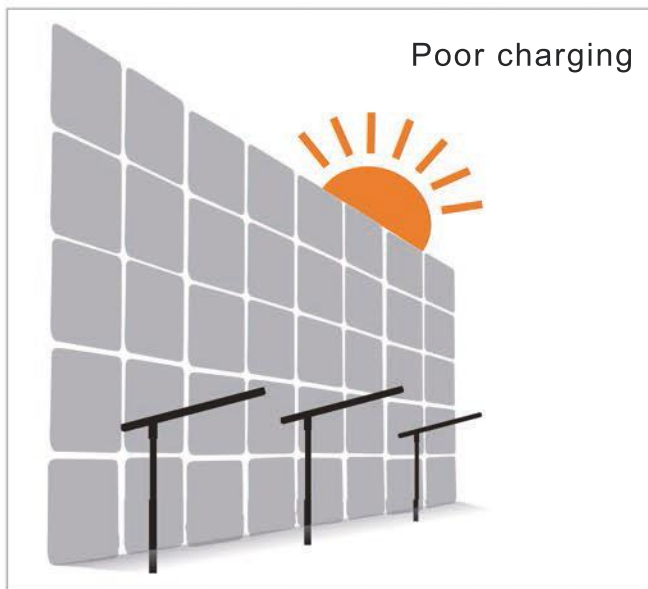

- Please choose a place that is sunny and fully exposed, then install integrated solar street lights.
- And note that the solar panels must be unobstructed and must be exposed to the sun.

Case shows:



Road



Mountains



Rural



Street



Square



Park



School



Certificate:



CE



IP66



RoHS

Contact us:



+86-0755-29360050



andy@centurysunshine.com



6-7F, 1#, B Area, Xifa Industrial Park, Yintian Industrial Zone, Xixiang, Bao'an, Shenzhen, Guangdong Province